

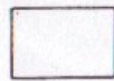

# Le drapeau du Royaume-Uni

## Matériel nécessaire :

 Une feuille A4

 Des crayons de couleur



Un tube de colle



Une paire de ciseaux

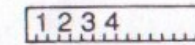

Une règle

CM1-CM2

1

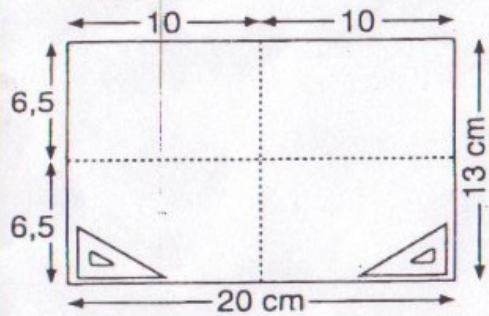

2



Colorier les bandes en rouge

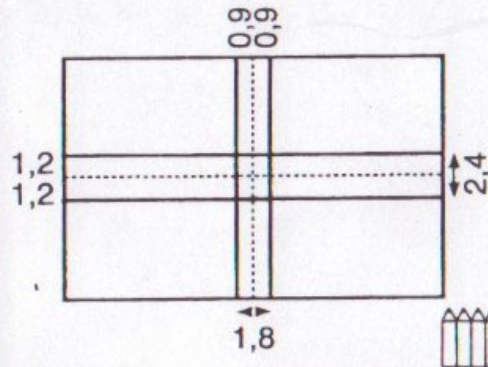

3

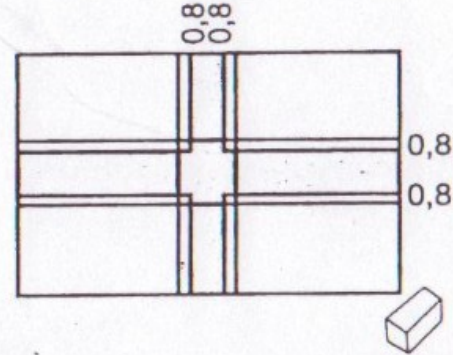
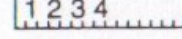

4

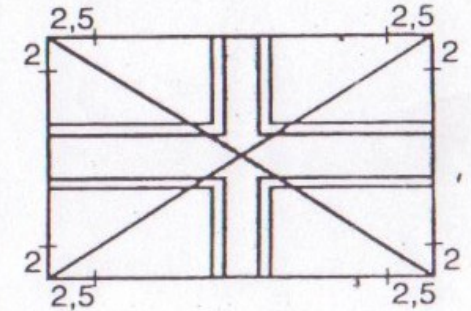
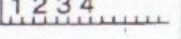

5

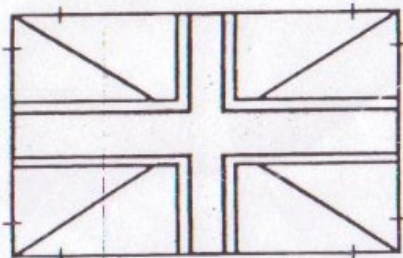

6

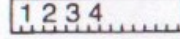

Tracer des traits parallèles

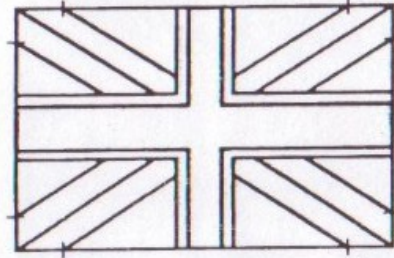

7

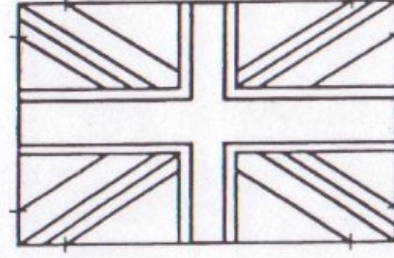
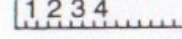

8

